



# MCH3375

## P-Channel Power MOSFET -30V, -1.6A, 295mΩ, Single MCPH3

ON Semiconductor®

<http://onsemi.com>

### Features

- ON-resistance  $R_{DS(on)1}=227m\Omega$ (typ.)
- 4V drive
- Halogen free compliance

### Specifications

Absolute Maximum Ratings at  $T_a=25^\circ\text{C}$

Parameter	Symbol	Conditions	Ratings	Unit
Drain to Source Voltage	$V_{DSS}$		-30	V
Gate to Source Voltage	$V_{GSS}$		$\pm 20$	V
Drain Current (DC)	$I_D$		-1.6	A
Drain Current (Pulse)	$I_{DP}$	$PW \leq 10\mu\text{s}$ , duty cycle $\leq 1\%$	-6.4	A
Allowable Power Dissipation	$P_D$	When mounted on ceramic substrate (900mm <sup>2</sup> ×0.8mm)	0.8	W
Channel Temperature	$T_{ch}$		150	°C
Storage Temperature	$T_{stg}$		-55 to +150	°C

This product is designed to "ESD immunity < 200V\*\*", so please take care when handling.

\* Machine Model

Stresses exceeding Maximum Ratings may damage the device. Maximum Ratings are stress ratings only. Functional operation above the Recommended Operating Conditions is not implied. Extended exposure to stresses above the Recommended Operating Conditions may affect device reliability.

### Package Dimensions

unit : mm (typ)

7019A-003

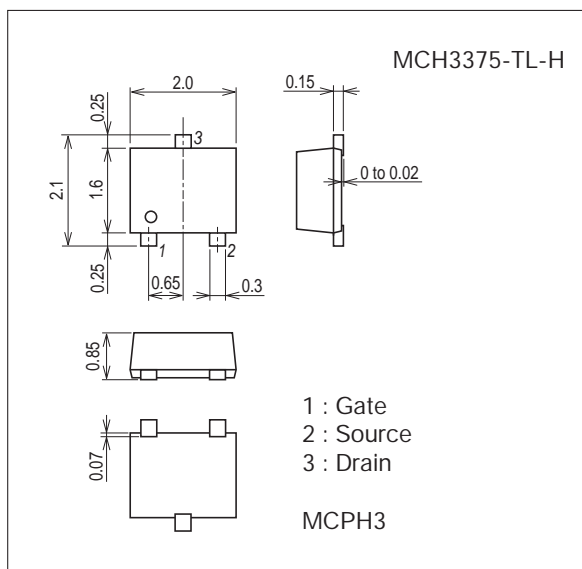

### Ordering & Package Information

Device	Package	Shipping	note
MCH3375-TL-H	MCPH3 SC-70, SOT-323	3,000 pcs./reel	Pb-Free and Halogen Free

### Packing Type: TL

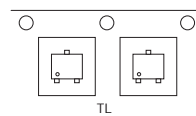

### Marking

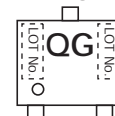

### Electrical Connection

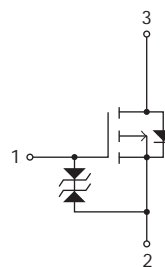

# MCH3375

## Electrical Characteristics at $T_a=25^\circ\text{C}$

Parameter	Symbol	Conditions	Ratings			Unit
			min	typ	max	
Drain to Source Breakdown Voltage	$V_{(BR)DSS}$	$I_D=-1\text{mA}, V_{GS}=0\text{V}$	-30			V
Zero-Gate Voltage Drain Current	$I_{DSS}$	$V_{DS}=-30\text{V}, V_{GS}=0\text{V}$			-1	$\mu\text{A}$
Gate to Source Leakage Current	$I_{GSS}$	$V_{GS}=\pm 16\text{V}, V_{DS}=0\text{V}$			$\pm 10$	$\mu\text{A}$
Cutoff Voltage	$V_{GS(off)}$	$V_{DS}=-10\text{V}, I_D=-1\text{mA}$	-1.2		-2.6	V
Forward Transfer Admittance	$ y_{fs} $	$V_{DS}=-10\text{V}, I_D=-0.8\text{A}$		1.3		S
Static Drain to Source On-State Resistance	$R_{DS(on)1}$	$I_D=-0.8\text{A}, V_{GS}=-10\text{V}$		227	295	$\text{m}\Omega$
	$R_{DS(on)2}$	$I_D=-0.4\text{A}, V_{GS}=-4.5\text{V}$		374	523	$\text{m}\Omega$
	$R_{DS(on)3}$	$I_D=-0.4\text{A}, V_{GS}=-4\text{V}$		435	609	$\text{m}\Omega$
Input Capacitance	$C_{iss}$			82		$\text{pF}$
Output Capacitance	$C_{oss}$	$V_{DS}=-10\text{V}, f=1\text{MHz}$		22		$\text{pF}$
Reverse Transfer Capacitance	$C_{rss}$			16		$\text{pF}$
Turn-ON Delay Time	$t_{d(on)}$	See specified Test Circuit.		4.0		ns
Rise Time	$t_r$			3.3		ns
Turn-OFF Delay Time	$t_{d(off)}$			12		ns
Fall Time	$t_f$			5.4		ns
Total Gate Charge	$Q_g$				2.2	
Gate to Source Charge	$Q_{gs}$	$V_{DS}=-15\text{V}, V_{GS}=-10\text{V}, I_D=-1.6\text{A}$		0.36		nC
Gate to Drain "Miller" Charge	$Q_{gd}$			0.49		nC
Diode Forward Voltage	$V_{SD}$	$I_S=-1.6\text{A}, V_{GS}=0\text{V}$		-0.9	-1.5	V

## Switching Time Test Circuit

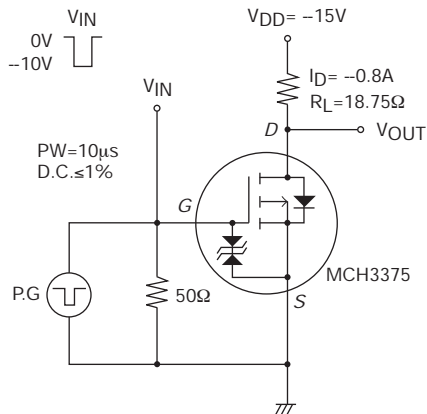

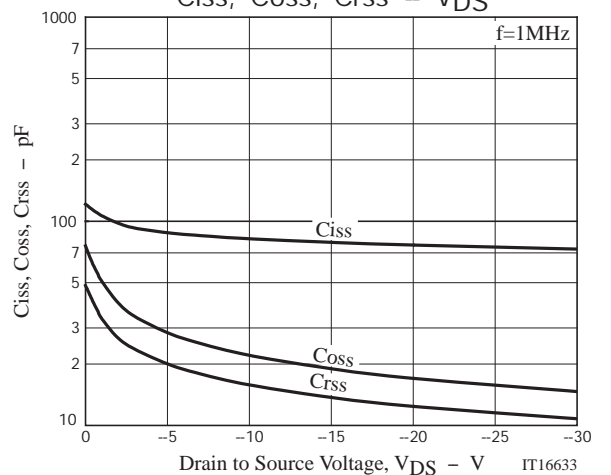
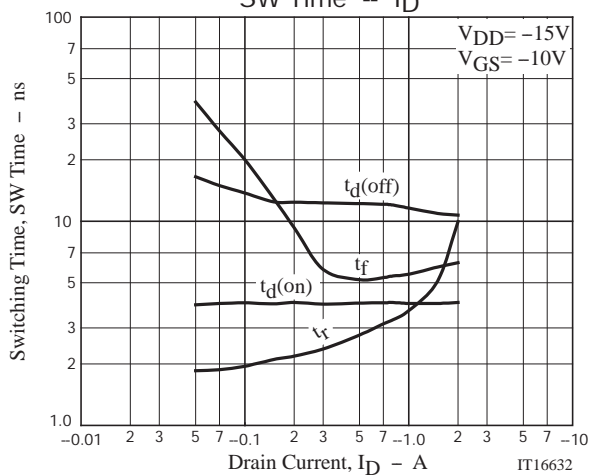
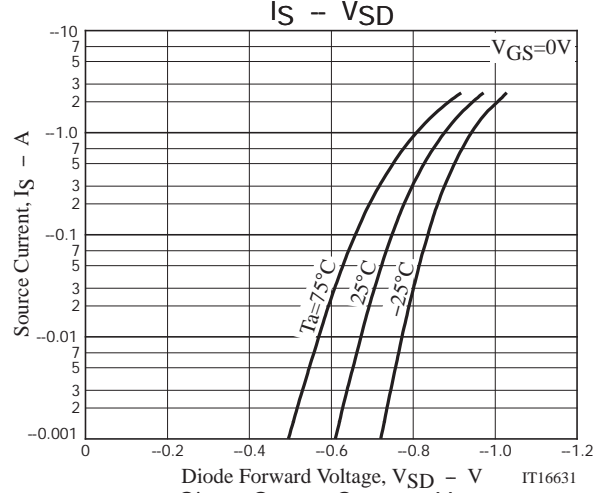
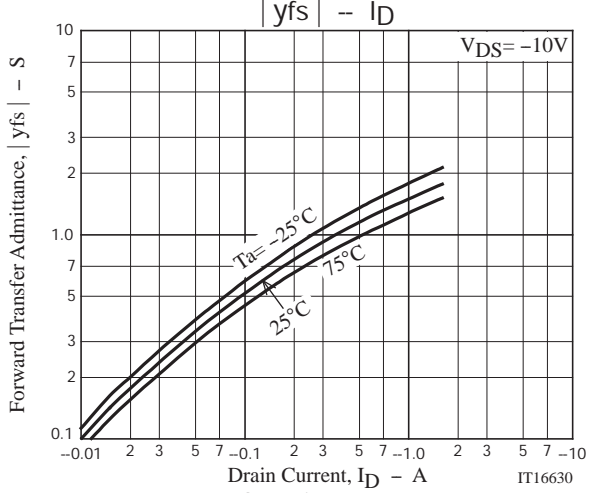
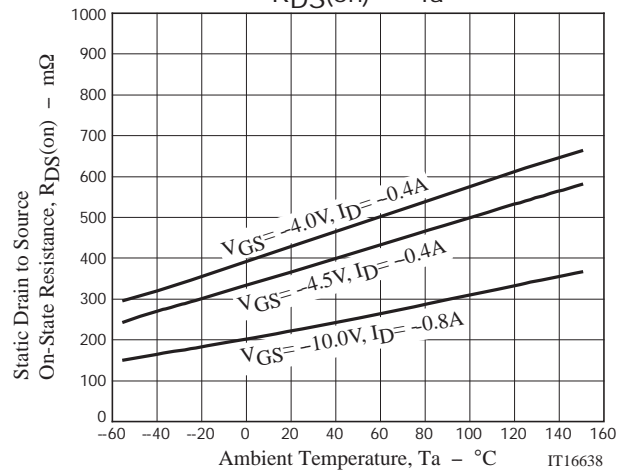
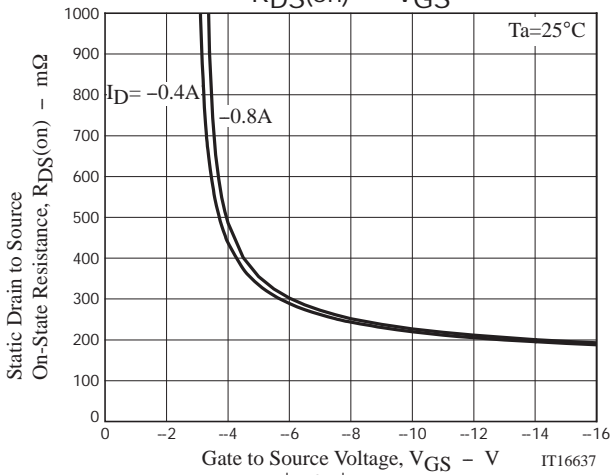
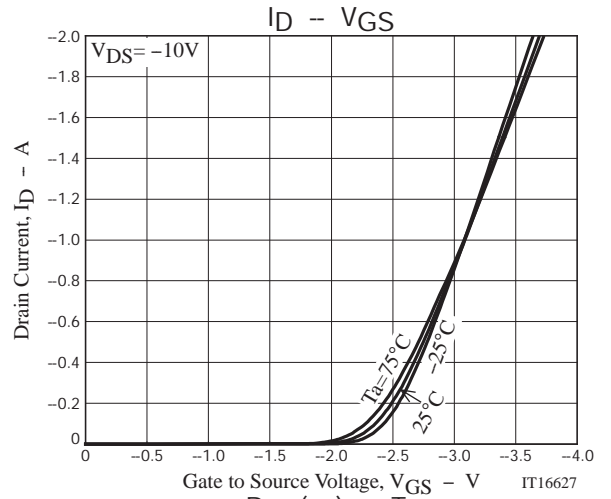
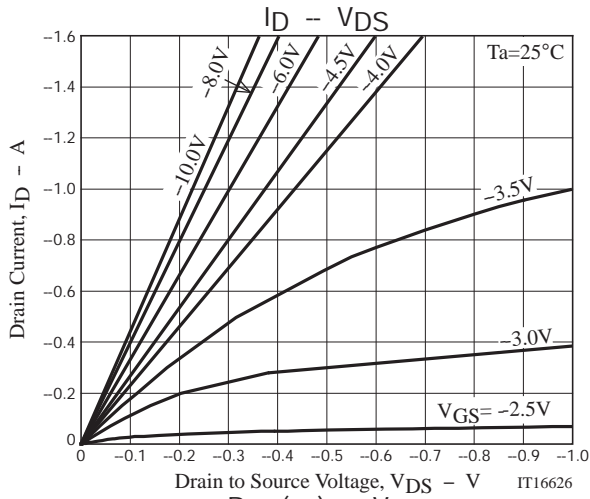

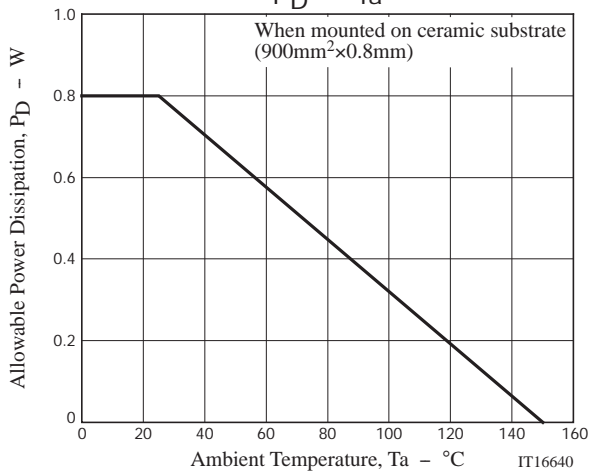
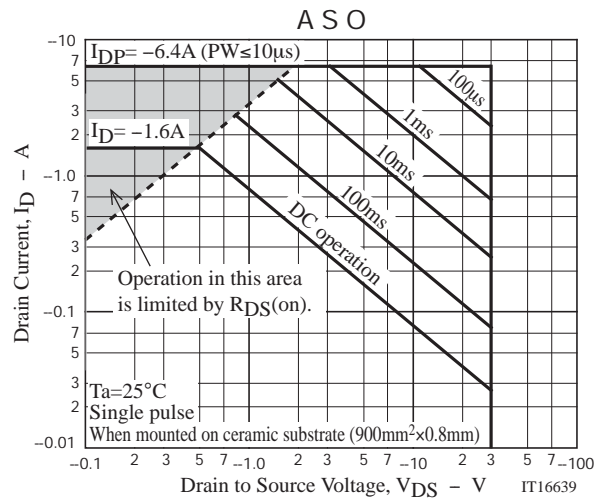
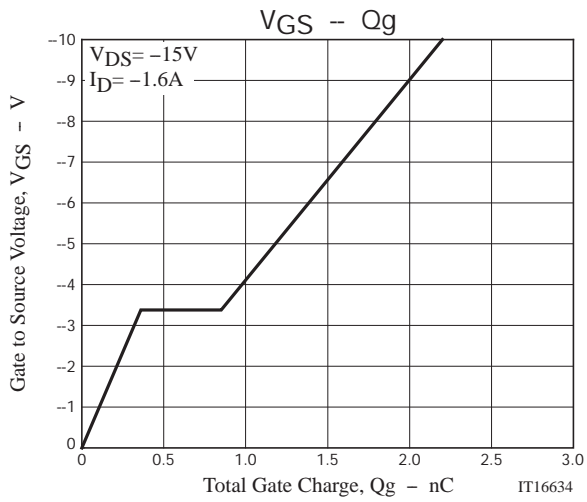

Taping Specification

MCH3375-TL-H

1. Packing Format

Package Name	Carrier Tape Type	Maximum Number of devices contained (pcs)			Packing format	
		Reel	Inner box	Outer box	Inner BOX (C-1)	Outer BOX (A-7)
MCPH3	MCPH3	3,000	15,000	90,000	5 reels contained Dimensions:mm (external) 183×72×185	6 inner boxes contained Dimensions:mm (external) 440×195×210

Packing method

Reel label, Inner box label (unit:mm)      Outer box label

It is a label at the time of factory shipments. The form of a label may change in physical distribution process.

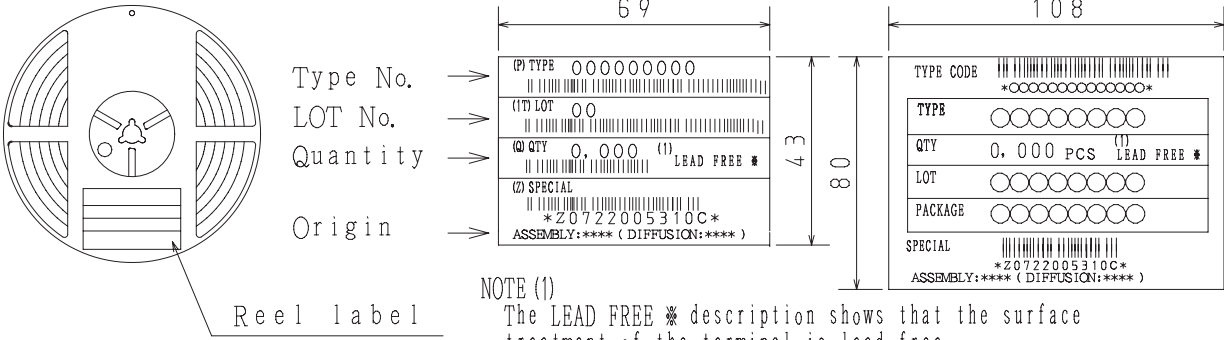

Label	JEITA Phase
LEAD FREE 3	JEITA Phase 3A
LEAD FREE 4	JEITA Phase 3

2. Taping configuration

2-1. Carrier tape size (unit:mm)

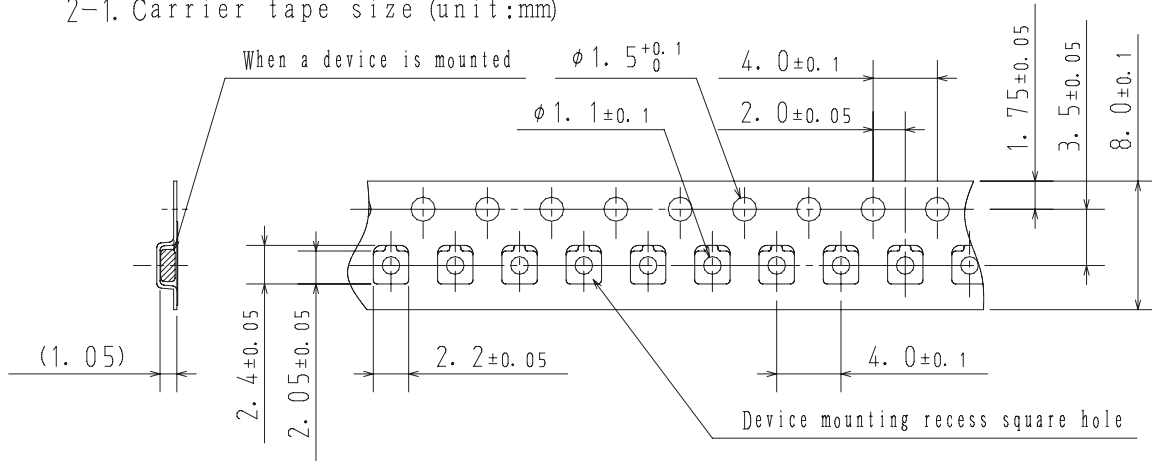

2-2. Device placement direction

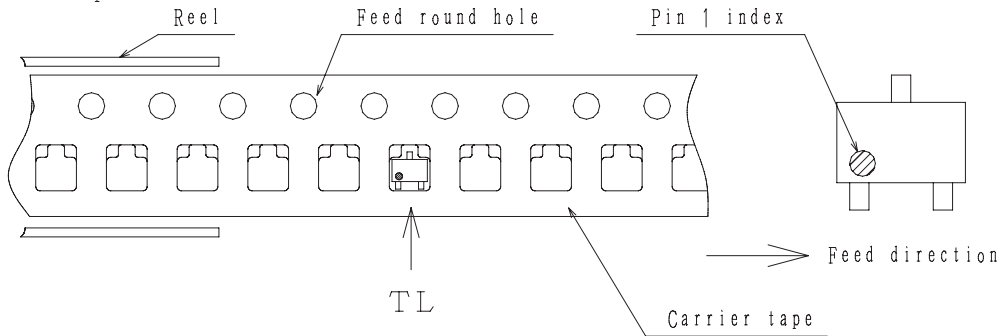

Those with pin 1 index on the feed hole side.....TL

# MCH3375

## Outline Drawing MCH3375-TL-H

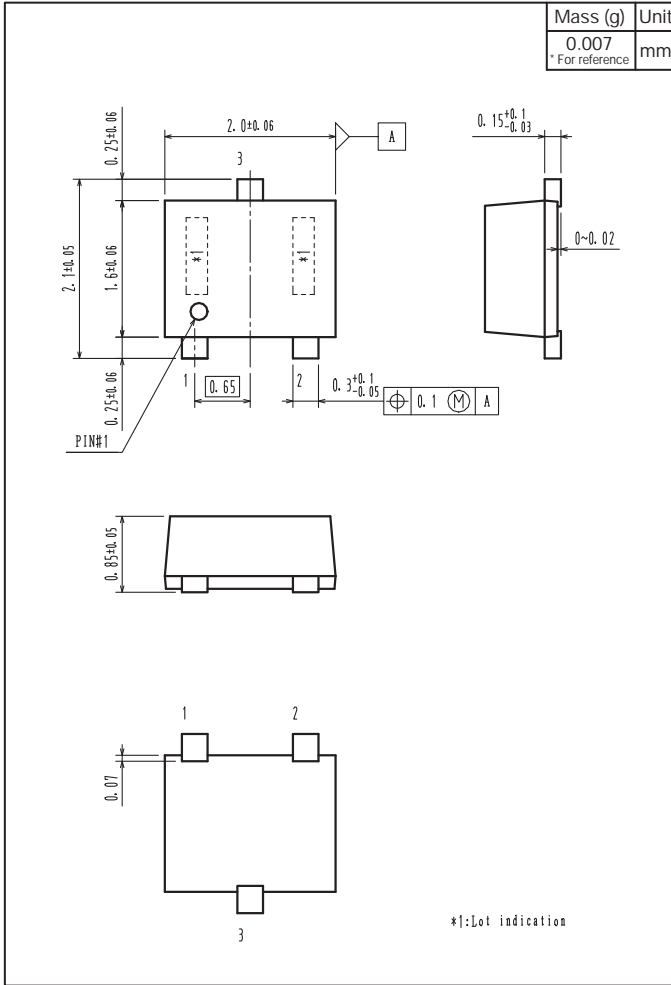

## Land Pattern Example

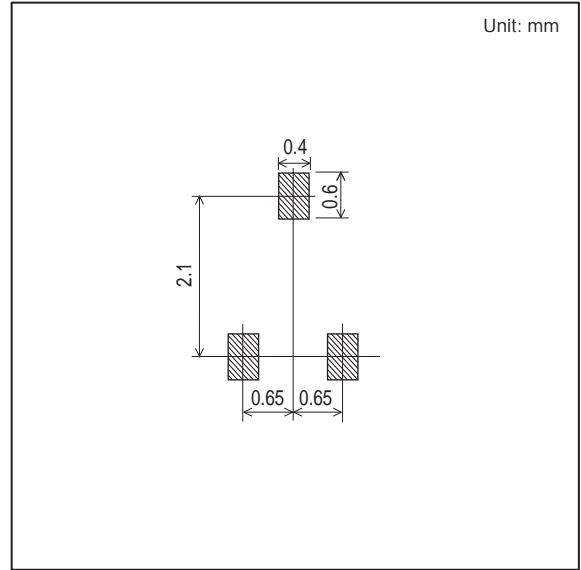

Note on usage : Since the MCH3375 is a MOSFET product, please avoid using this device in the vicinity of highly charged objects.

ON Semiconductor and the ON logo are registered trademarks of Semiconductor Components Industries, LLC (SCILLC). SCILLC owns the rights to a number of patents, trademarks, copyrights, trade secrets, and other intellectual property. A listing of SCILLC's product/patent coverage may be accessed at [www.onsemi.com/site/pdf/Patent-Marking.pdf](http://www.onsemi.com/site/pdf/Patent-Marking.pdf). SCILLC reserves the right to make changes without further notice to any products herein. SCILLC makes no warranty, representation or guarantee regarding the suitability of its products for any particular purpose, nor does SCILLC assume any liability arising out of the application or use of any product or circuit, and specifically disclaims any and all liability, including without limitation special, consequential or incidental damages. "Typical" parameters which may be provided in SCILLC data sheets and/or specifications can and do vary in different applications and actual performance may vary over time. All operating parameters, including "Typicals" must be validated for each customer application by customer's technical experts. SCILLC does not convey any license under its patent rights nor the rights of others. SCILLC products are not designed, intended, or authorized for use as components in systems intended for surgical implant into the body, or other applications intended to support or sustain life, or for any other application in which the failure of the SCILLC product could create a situation where personal injury or death may occur. Should Buyer purchase or use SCILLC products for any such unintended or unauthorized application, Buyer shall indemnify and hold SCILLC and its officers, employees, subsidiaries, affiliates, and distributors harmless against all claims, costs, damages, and expenses, and reasonable attorney fees arising out of, directly or indirectly, any claim of personal injury or death associated with such unintended or unauthorized use, even if such claim alleges that SCILLC was negligent regarding the design or manufacture of the part. SCILLC is an Equal Opportunity/Affirmative Action Employer. This literature is subject to all applicable copyright laws and is not for resale in any manner.